

Specifications

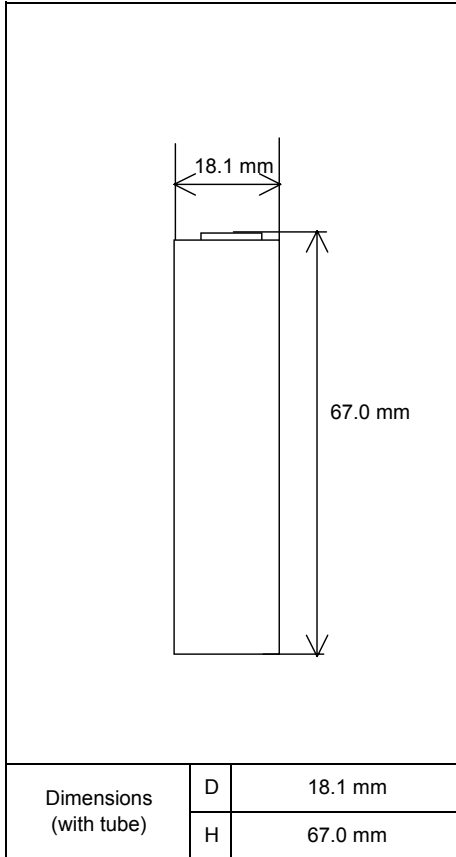

Type : Nickel-Metal Hydride Battery		Size : 4/3FA
Capacity ¹⁾	Typical	3200mAh
	Minimum	3050mAh
Nominal Voltage		1.2V
Charging Current x Time	Fast Charge ²⁾	3200 mA x about 1.1h
Ambient Temp.	Charge Condition	Fast Charge ²⁾ 0°C - 40°C
	Discharge Condition	0°C - 50°C
	Storage Condition	Less than 30days
Less than 90days		-20°C - 40°C
Less than 1year		-20°C - 30°C
Internal Impedance ³⁾ (after discharge to E.V.=1.0V)		Approx. 6mΩ(at 1000Hz)
Weight ⁴⁾		Approx. 59 g
Size ⁴⁾ : (Diameter) x (Height)		18.1(D) x 67.0(H) mm

1)Single cell capacity under the following condition.

Charge : 320mA×16h, Discharge : 640mA(E.V.=1.0V) at 20°C

2)Use recommended charging system.

3)After a few charge and discharge cycles under the above 1) condition.

4)With tube.

Typical Characteristics

Charge

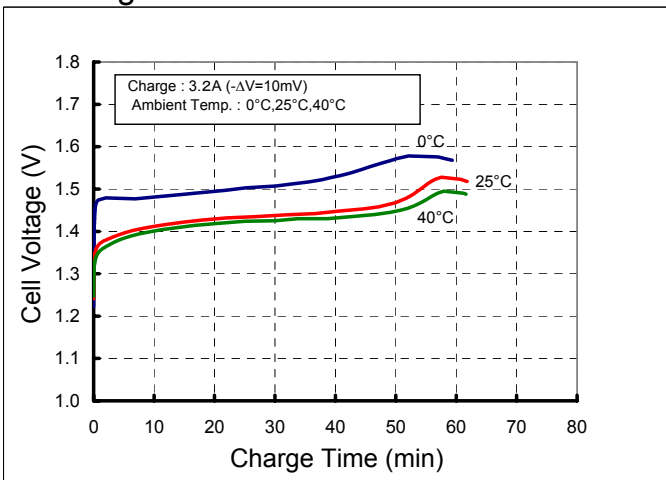

Discharge

